

5port Pilot Operated Solenoid Valve (SV)

SV3000 Series (Rc(PT) 1/4)

- 26.5mm Body width
- Transition Flow 1000 l/min (5bar)



How to order

SV 3 1 30 - 220V - GL - P - 02

- Solenoid valve**
- Function**
 - 1 - 2 position single
 - 2 - 2 position double
 - 3 - 3 position Closed Center
 - 4 - 3 position Exhaust Center
 - 5 - 3 position Pressure Center
- Coil Rate Voltage**
 - 220V - AC 220V
 - 110V - AC 110V
 - 24V - AC 24V
 - D24V - DC 24V
- Coil Type**
 - Nil - Without Coil
 - G - Flying Leads (Grommet)
 - GL - Flying Leads with LED lamp(Grommet)
 - C - 3 Pin coil + Connector
 - CL - 3 Pin coil + LED lamp Connector
- Manual Operator**
 - P - Push Button
- Thread Type**
 - Nil - Rc(PT)
 - N - NPT
 - G - G(PF)
- Port Size**
 - 02 - Rc(PT) 1/4(P, A, B), 1/8(R1, R2)

Symbol

2 Position Single

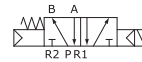

3 Position Closed Center



2 Position Double

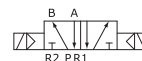

3 Position Exhaust Center



3 Position Pressure Center



Specification

Function	5port 2position	5port 3position
Fluid	Compressed air	
Ambient and Media temp.	5 ~ 60°C	
Max. operating pressure	1.5~10bar	2~10bar
Eff. Sectional Area(5bar)	19mm ²	11.5mm ²
Response time(5bar)	25ms or less	35ms or less
Max. operating frequency	5c/sec	3c/sec
Lubrication	Not required	
Manual override	Push button	
Coil insulation	F-Class or Equivalent	
Allowable voltage	±10% rated voltage	
Power consumption	AC:4.9VA(60Hz) / DC:2.5W	

DIMENSIONS (mm)

2position / 5port single(Grommet type)

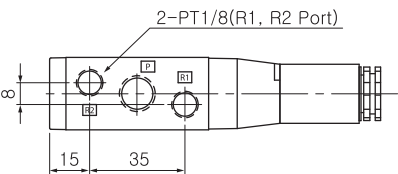
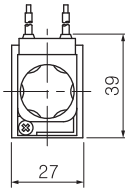
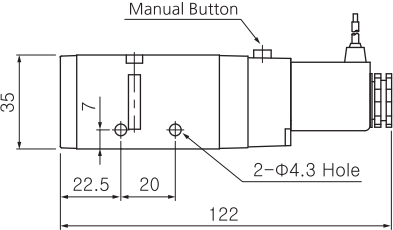
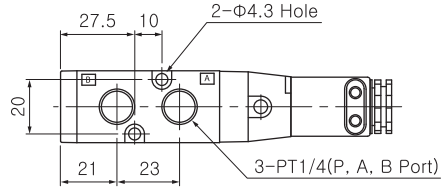

SV3130-□□□V-G-...

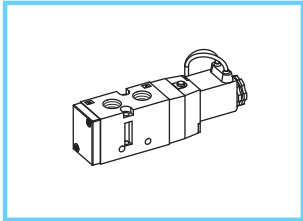

2position / 5port single(Lamp type)

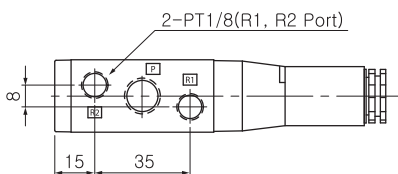
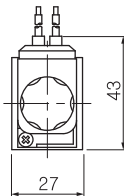
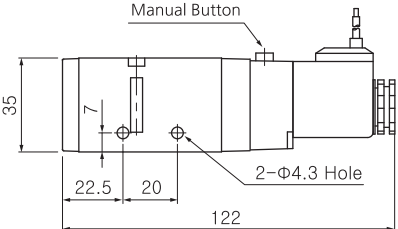
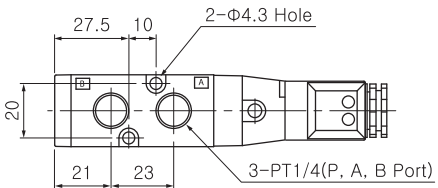

SV3130-□□□V-GL-...

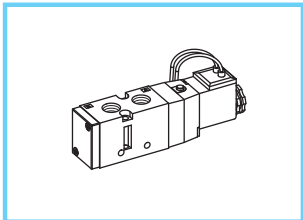

Series SV3000

DIMENSIONS (mm)

2position / 5port single(Connector type)

SV3130-□□□V-C□-...

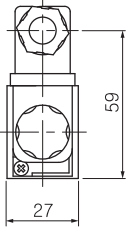
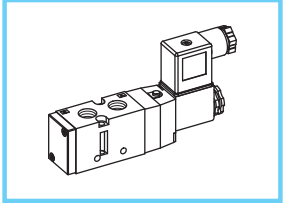
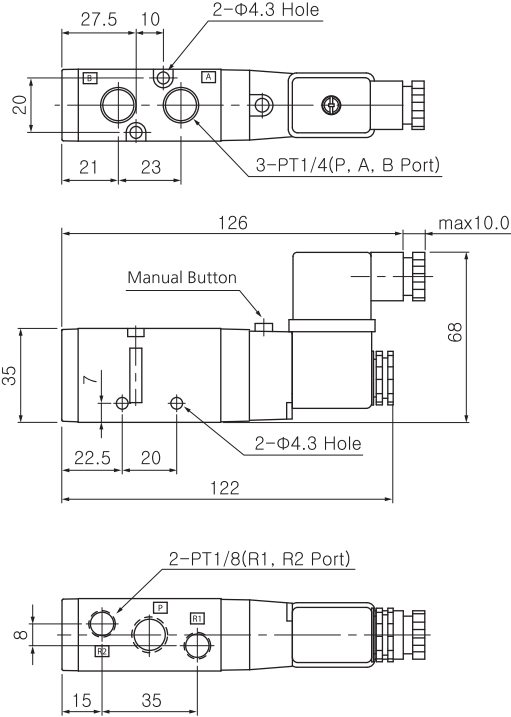

2position / 5port double(Grommet type)

SV3230-□□□V-G...

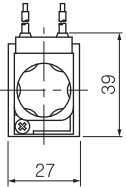
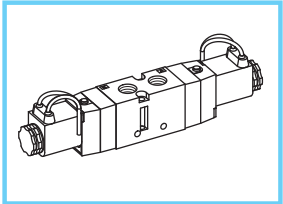
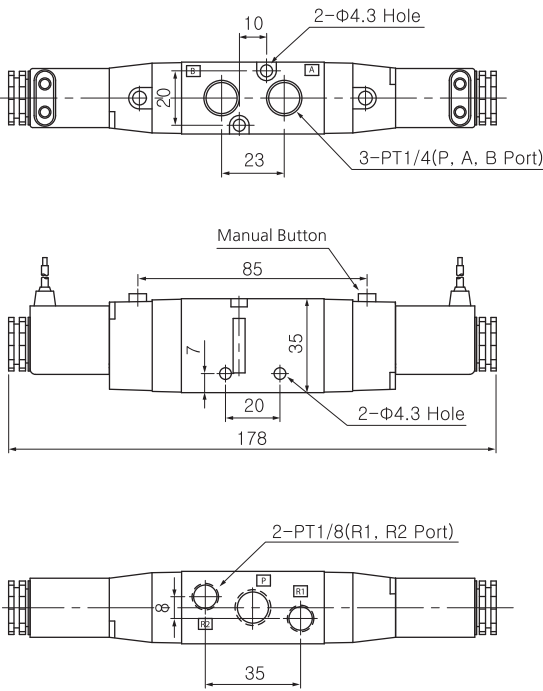

DIMENSIONS (mm)

3position / 5port double(Grommet type)

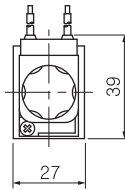
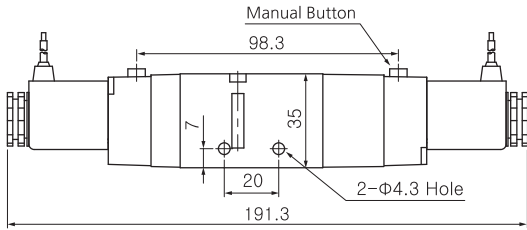
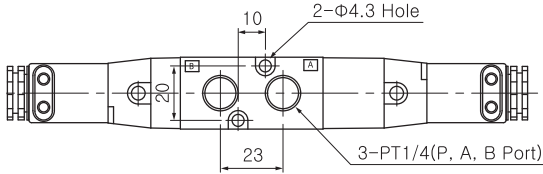

SV3330-□□□V-G-...

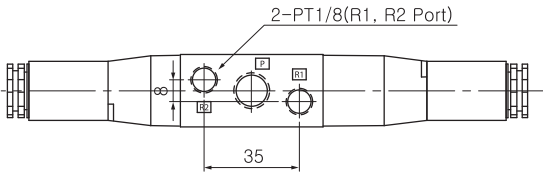
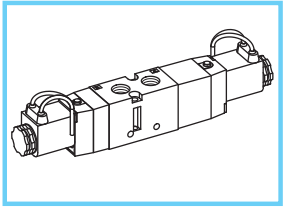

3position / 5port double(Lamp type)

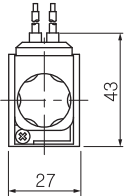
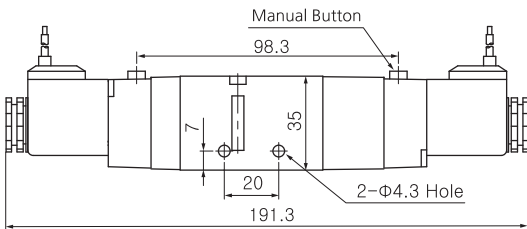
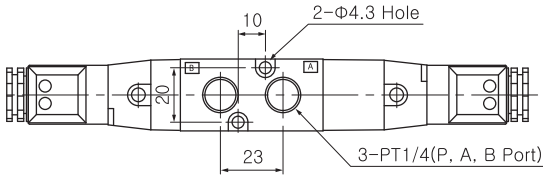

SV3330-□□□V-GL-...

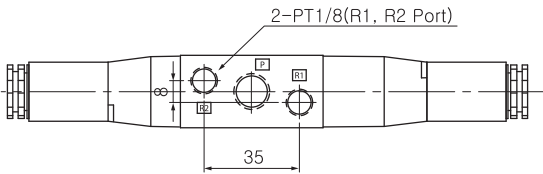
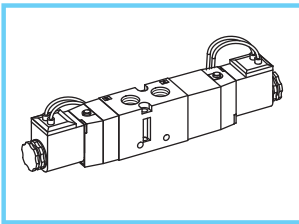

Series SV3000

DIMENSIONS (mm)

3position / 5port double(Connector type)

SV3330-□□□V-C□-...

